



**TECHNICAL CHARACTERISTICS**

- Low weight cast aluminum impeller and cast iron casing
- Smooth operation
- High efficiency impeller
- Maintenance free
- Mountable in any position

**OPTIONS**

- Special voltages (IEC 38)
- Surface treatments

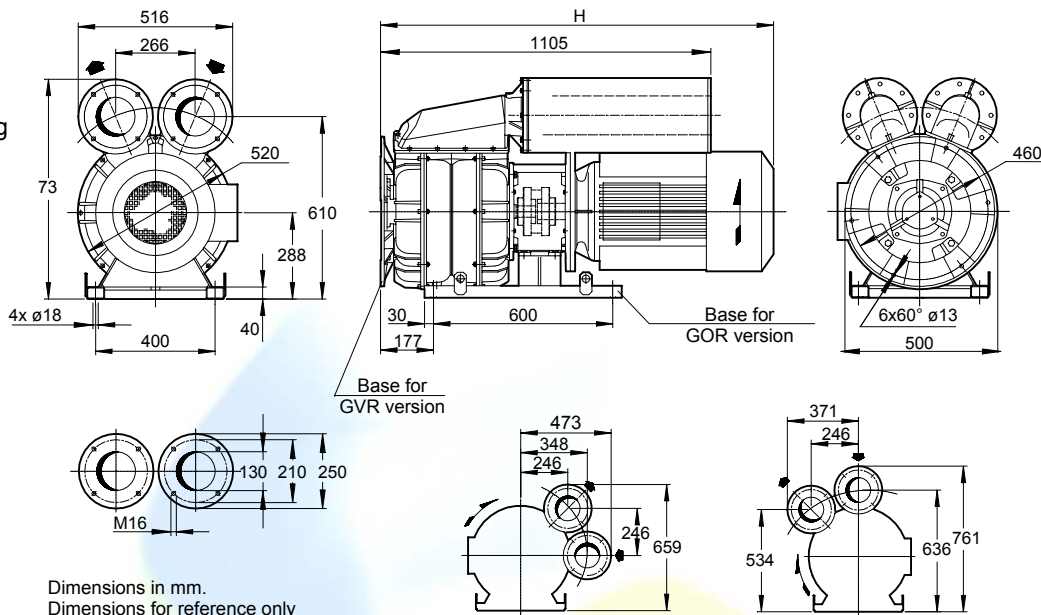

Dimensions in mm.  
Dimensions for reference only

Model	Maximum flow m³/h		Installed power kW		Maximum differential pressure Δp hPa ( mbar )		Noise level Lp dB (A) (1)		Overall dimensions H mm	Weight Kg	
	50 Hz 2900 rpm	60 Hz 3500 rpm	50 Hz 2900 rpm	60 Hz 3500 rpm	50 Hz 2900 rpm	60 Hz 3500 rpm	50 Hz 2900 rpm	60 Hz 3500 rpm		GOR	GVR
115SH	2150	2600	11.0	-	100	-	93.8	-	1200	382	355
			15.0	15.0	150	100	94.1	96.8	1200	382	355
			18.5	18.5	200	150	94.4	97.1	1200	397	370
			22.0	22.0	250	200	94.7	97.4	1255	457	430
			30.0	30.0	400	275	95.0	97.7	1290	523	496
			-	37.0	-	350	-	98.0	1315	543	516

(1) Noise measured at 1 m distance with inlet and outlet ports piped, in accordance to ISO 3744.

- For proper use, the blower should be equipped with inlet filter and safety valve; other accessories available on request.
- Ambient temperature from -15° to +40°C.
- Specifications subject to change without notice.

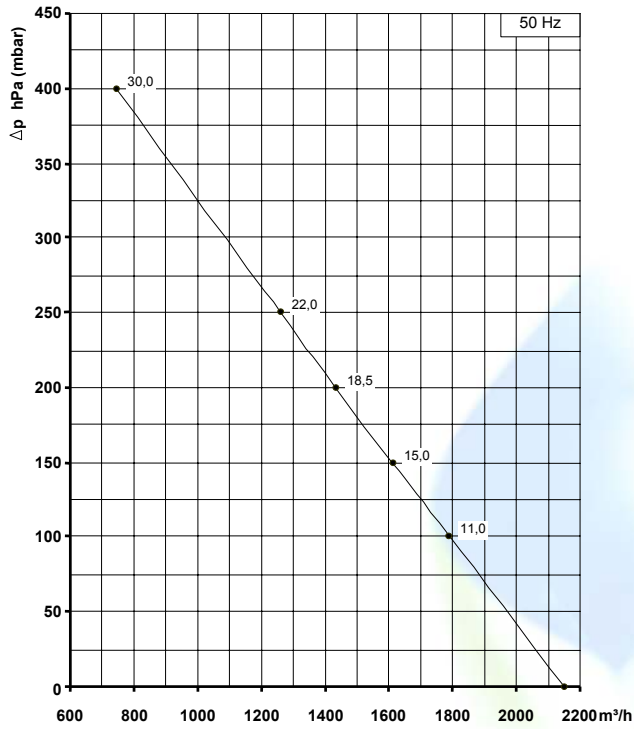

**CAPACITY**

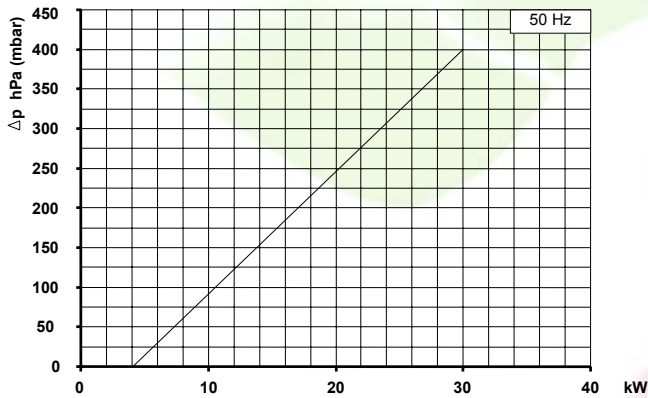
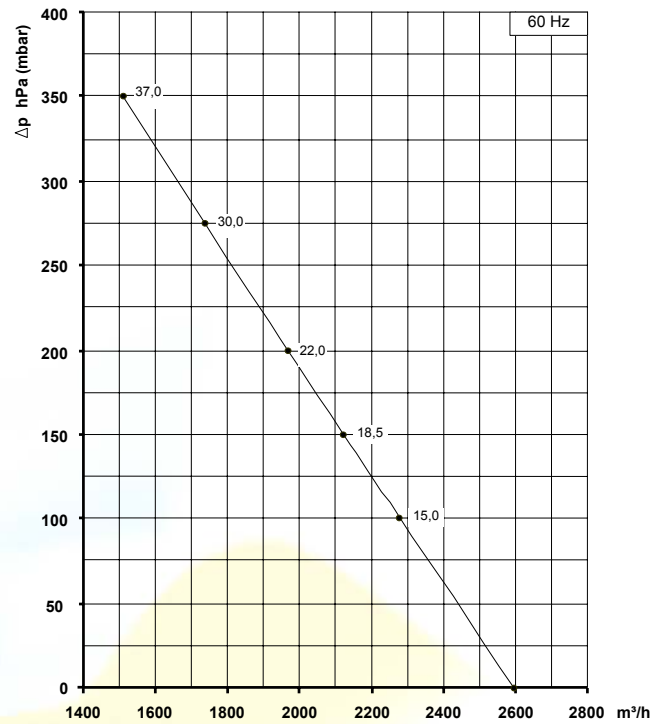

**ABSORBED POWER**

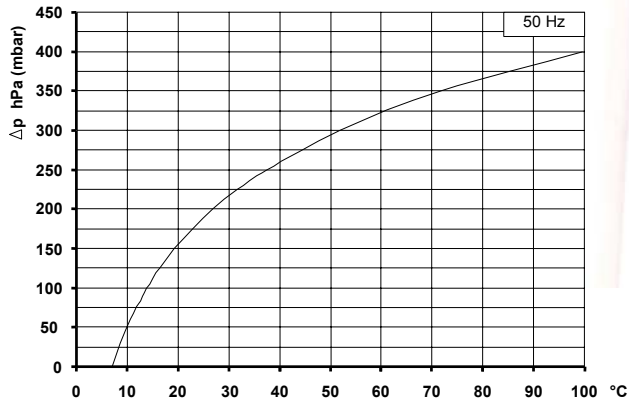
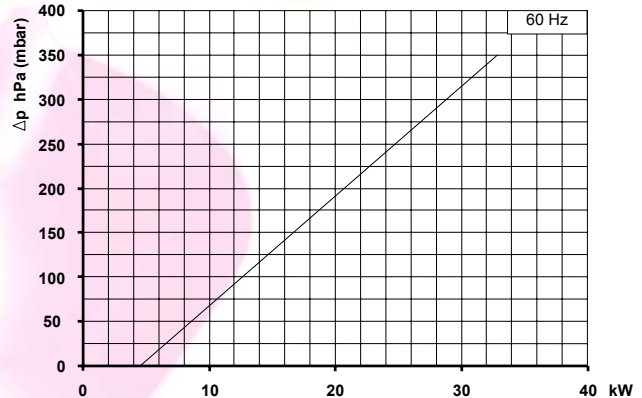

**TEMPERATURE INCREASE**

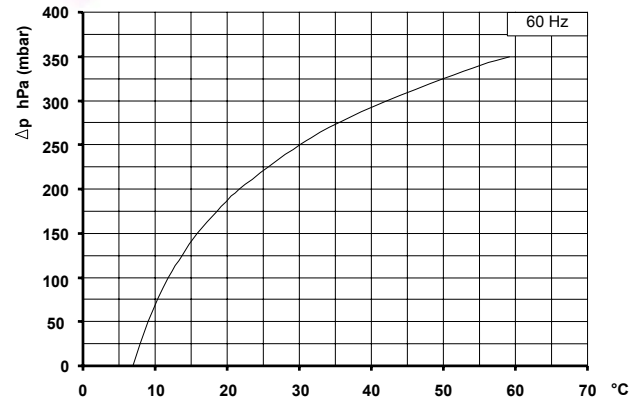

Curves refer to air at 20°C temperature and 1013 mbar (abs) atmospheric pressure measured at inlet port.  
 Values for flow, power consumption and temperature rise: +/-10% tolerance.  
 Data can change without prior notice.